

Varenummer: 20967466
Beskrivelse: E+G Justerfod
GN 343.7-50-M10-A

Mål

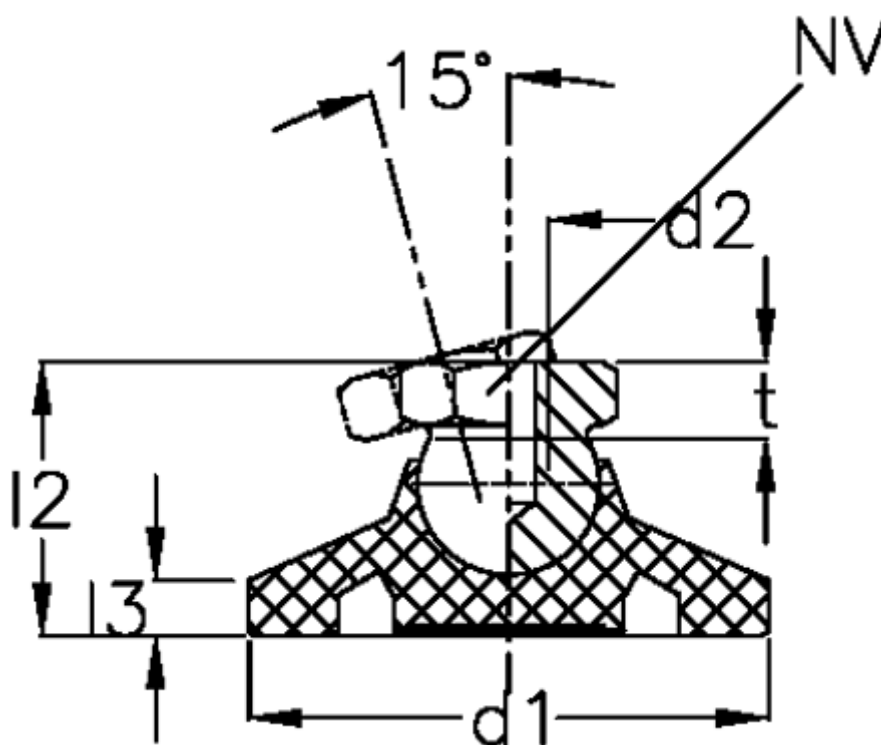

d_1	= 50
d_2	= M10
l_2	= 27.5
l_3	= 7.0
NV	= 15
Statisk belastning (N)	= 10000
t min	= 10.5